

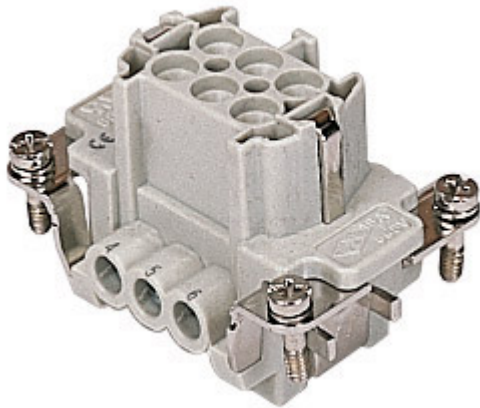

Part number



CNEF 06 TX



Brief description:

female insert, 6 poles + PE, screw terminal connections, 16A, 500V, 6kV, 3, silver plated, size "44.27", CLASS insert series

Product description	
Model	female insert
Version	screw terminal connections
Series	CNE
Product type	with female contacts
Variant	without plate
Family	CLASS inserts
Size	size "44.27"
N. of poles	6 poles + 
Technical data	
Current	16 A (A.C. and D.C.)
Voltage	500 V
Rated impulse withstand voltage	6kV
Pollution degree	3
Wire cross-section	0,25 mm ² - 2,50 mm ²
AWG size	24 - 14
Operating temperature range (min, max)	-50°C ... +70°C
Contact type	silver plated
Mating cycles	≥ 200
IP degree of protection	IP20 without enclosure; IP65/IP66/IP67/IP68 with enclosure
PE terminal stripping length	7 mm
PE wire cross-section	0,14 - 4 mm ² ; AWG 20 - 12
Further technical details	
Characteristics according to EN 61984	16A 500V 6kV 3; 16A 400/690V 6kV 2
Insulation resistance	≥ 1 GΩ
Rated voltage according to UL/CSA	600V
UL 94 flammability rating	V-0
Weight	55,00 g

Approvals / Standards	
Reference standard	EN 61984 (2001-11)
Quality mark	   EAC
Conformity	CQC, CE
General ordering information	
EAN13 code	8015747032100
Tariff number	85369095
Country of origin	Made in EU (IT)
ETIM classification	EC000438
Packaging Information	
Packaging length	210,00 mm
Packaging height	130,00 mm
Packaging width	240,00 mm
Packaging weight	3,30 kg
Packaging volume	6,55 dm ³
Packaging description	Carton box
Packaging quantity	60 Pcs
Packaging EAN code	8015747032117
Sub-packaging weight	0,55 kg
Sub-packaging description	Carton
Sub-packaging quantity	10 Pcs
Sub-packaging EAN barcode	8015747032124

Part number

CNEF 06 TX



Catalogue drawings

CNEM 06

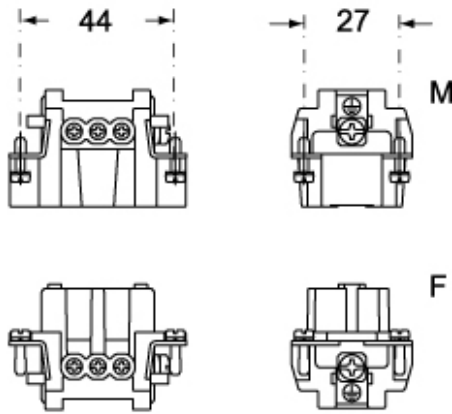

CNEF 06

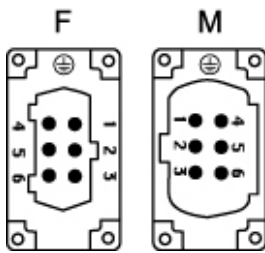

Catalogue drawings

diagram CN, CNE and CCE 06 poles

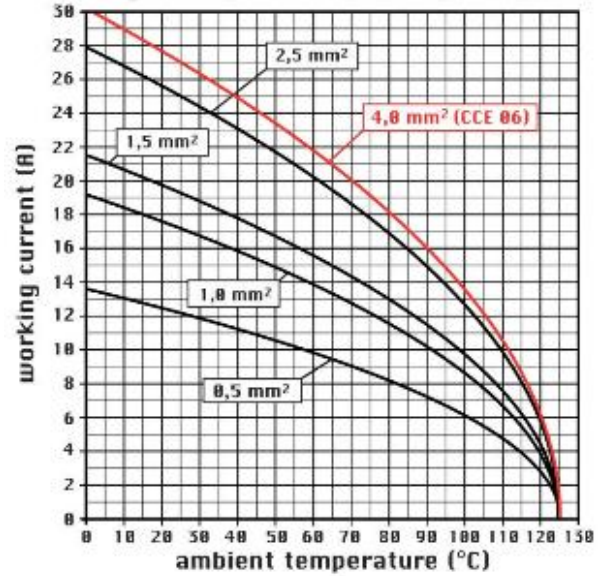

Notes

CNE ... : for non-prepared conductors



CNE ... X : for conductors with bush terminal